

Event Title:	One Refurbished Aircraft Stair Truck		
Event Number:	7150		
Close Date:	Tuesday, May 21, 2019		
Addendum(s):	0		
	Vendor(s):	Addendum	Total Bid
	Advanced GSE Corp	n/a	\$45,500.00
	1850 Bonhill Road		
	Mississauga, ON L5T1C4		
	Houston International Aircraft Support, Inc.	n/a	\$48,000.00
	P.O. Box 2079		
	New Waverly, TX 77358		
	Mercury GSE	n/a	\$48,500.00
	9445 Ann St.		
	Santa Fe Springs, CA 90670		

This Page Intentionally Left Blank

Response For Supplier: MERCURY GSE

Event # : 7150-0

Name: One Refurbished Aircraft Stair Truck

Reference: Savannah Hilton Head Airport

Description: The purpose of these specifications is to obtain one refurbished self-propelled aircraft stair truck for use by the Savannah Airport Commission in its daily operations.

Preview Date:

Q & A Open Date: 05/03/2019 08:00:00 AM

Open Date: 05/02/2019 05:00:00 PM

Q & A Close Date: 05/13/2019 12:00:00 PM

Close Date: 05/21/2019 01:30:00 PM

Dispute Close Date:

Responded To: 1 out of 1 lines

Total Bid Amount: \$48,500.00 USD

Question Responses

Question

Answer

Delivery time will be a factor in the award of this contract. Please state the number of business days required for delivery after receipt of purchase order. 14

Response Attachments

Attachment

IMG_0003.JPG

P1010073.JPG

5-8-19 RFQ FOR STAIR TRUCK SAVANNAH AIRPORT.docx

TLPH 252 STAIR -1-4-19.pdf

Line Responses

Line 1: Refurbished Aircraft Stair Truck

Event # 7150-0: One Refurbished Aircraft Stair Truck

Description: Refurbished Aircraft Stair Truck

Item: REFURBISHED AIRCRAFT STAIR TRUCK AIRCRAFT STAIR TRUCK

Commodity Code: 975-10 Airport Equipment and Accessories Rental or Lease

Quantity: 1.0000

UOM: EA

Bid Quantity: 1.0000

Unit Price: 48,500.00000

Extended Price: 48,500.00

No Charge: No

No Bid: No

Vendor Item: 3944 Wollard TLPH252SMT



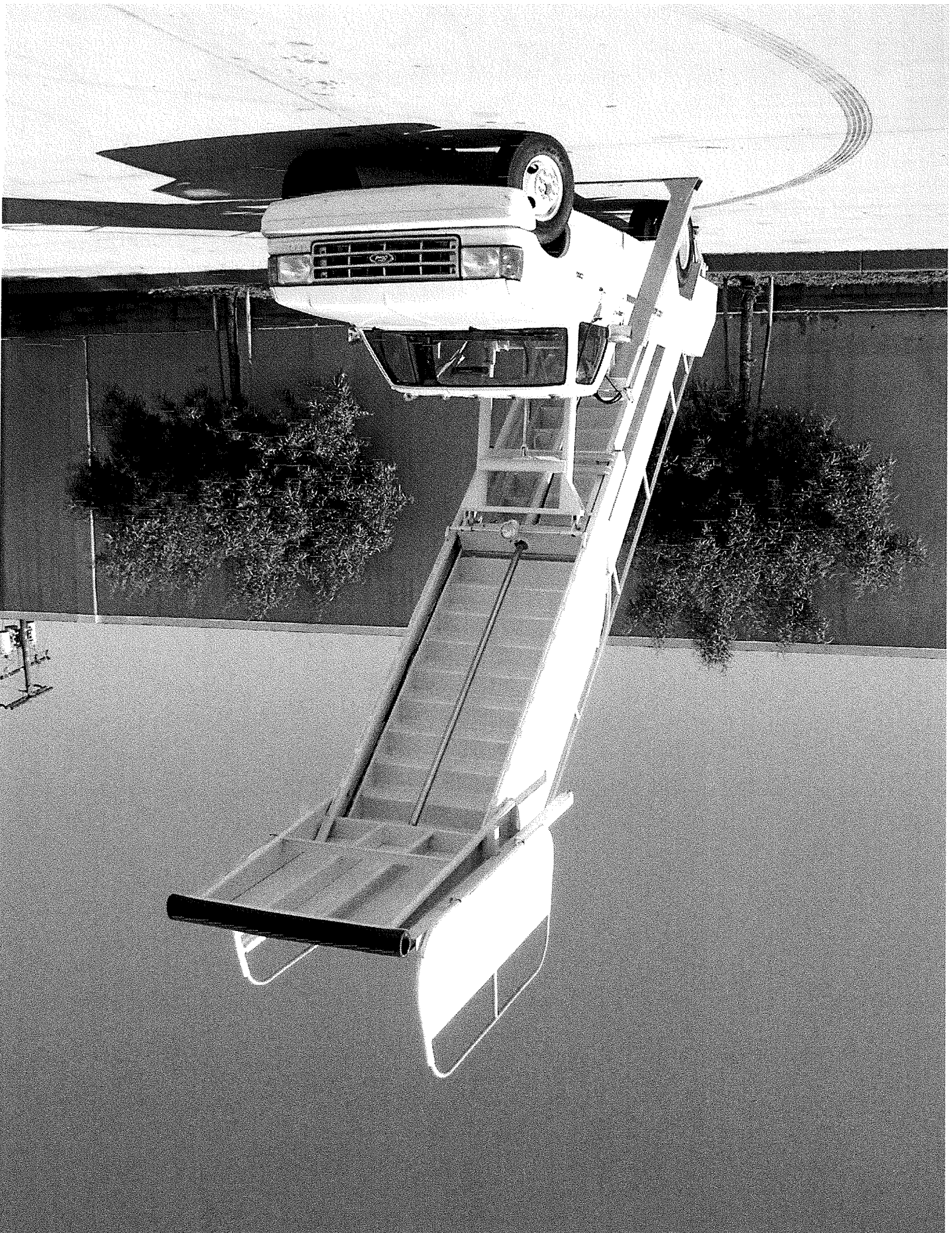

MERCURY GSE

Ground Support Equipment Sales – Lease - Rentals

Date: 5/8/19

Company: Savannah Airport

Attention:

From: Rose Valle

Ph#: (562)653-0654

E-mail: rvalle@mercurygse.com

Ref: RFQ

Reference: RFQ FOR GROUND SUPPORT EQUIPMENT

Further to your valued inquiry, Mercury GSE is pleased to offer the following stair truck:

1 EACH:	<u>USED WOLLARD STAIR TRUCK</u>
Manufactured By:	Wollard Airport Equipment Co., Inc.
Year:	1989
Model:	TLPH-252SMT (Ford F350 Chassis)
Engine:	Ford Gasoline
Engine Model:	6 Cylinder Gas Injection
Transmission :	Automatic
GVW:	11,000lbs (4,990kgs)
Features:	Will Service All Aircraft Having Doorsill Heights Ranging From 100" (254cm) To 200" (508cm).
Work Scope:	This unit is airline service ready at this time
Paint:	Freshly painted White.
FOB:	Santa Fe Springs, CA
Delivery:	7 days from receipt of order / deposit.
Sales Price:	\$48,500 Each Painted your single color
Warranty:	30 Days Parts only.

MERCURY GSE

Ground Support Equipment Sales – Lease - Rentals

ALL EQUIPMENT MUST REMAIN SUBJECT TO PRIOR RENTAL OR SALE

SALES TERMS

- TRANSPORT:** Transportation to Savannah, GA is included.
- TERMS:** To reserve this equipment and set delivery in motion we require your official purchase order and a deposit of 45% with the balance due prior to shipment.
- SALES TAX:** Any applicable sales tax is not included in the above price.

We thank you for giving us the opportunity to quote for your ground equipment needs and we look forward to working with you on this requirement. Should you have any questions or comments regarding the above, please feel free to contact me.

Rose Valle, Leasing Manager
Mercury GSE | Ground Support Equipment Sales & Rentals
t: (562) 653-0654 x405
9445 Ann Street, Santa Fe Springs, CA 90670 www.mercurygse.com

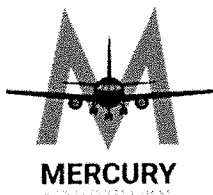

TMPS-200

NMC-WOLLARD Truck Mounted Passenger Stair

- Reaches doorsills up to 200 in. (508 cm)
- Hydraulically operated platform adjusts to aircraft doorsill.
- Hydraulic stabilizers — withstands 90 mph (145 kph) wind.
- Platform handrail panels retract to clear aircraft door swing.

Step capacity 200 lbs. (90 kg) each

High capacity

NMC-WOLLARD Truck Stair supports up to two adults per stair — up to 4 adults on upper platform. Allows quick loading and unloading of all aircraft with door sill heights from 100 in. (254 cm) to 200 in. (508 cm)

Protection

Stair has fully illuminated steps, platform — and a lower light illuminates the pavement in front of the lowest step. Other passenger protection features include safety tread steps, mechanical interlocks on moving sections, hydraulic stabilizers and constant height steps.

- Simple in-cab controls allow one-person operation.
- Mechanical interlocks hold stair in place if hydraulic pressure is lost.
- Aluminum handrails and diamond safety tread steps.
- Painted steel side panels.



NMC-WOLLARD

TMPS-200 Truck Mounted Passenger Stair

Specifications subject to change without notice. Photos and illustrations may show optional equipment.

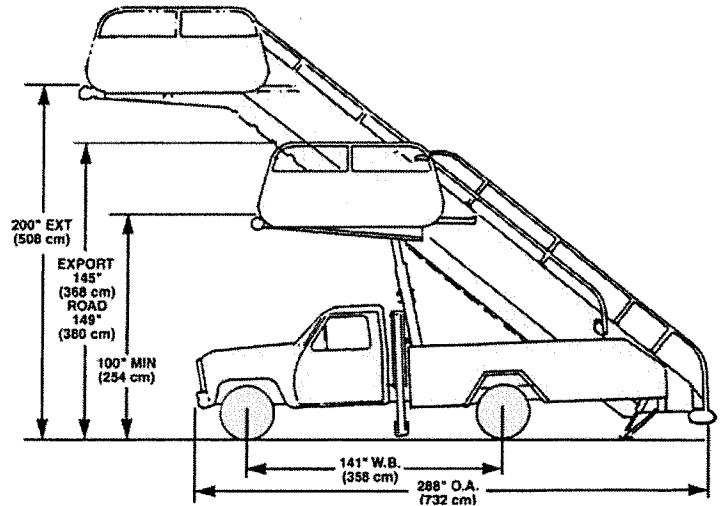

Aircraft Servicing Capability

All Aircraft having doorsill heights ranging from 100" (254 cm) to 200" (508 cm).

Height Range

Low Position..... 100 in. (254 cm)
High Position..... 200 in. (508 cm)

Stair Capacity

Platform..... 900 lbs. (409 kg) uniformly distributed load
Each Step..... 200 lbs.

Stair Dimensions

Nominal tread depth..... 10.05 in. (26 cm)
Nominal tread width (lower section)..... 42 in. (107 cm)
Nominal tread width (upper section)..... 47 in. (119 cm)
Top platform width..... 64 in. (163 cm)
Top platform depth..... 87 in. (221 cm)
Intermediate landing depth..... 19.75 in. (50 cm)
Constant riser height..... 7.85 in. (20 cm)

Hydraulic System

Cylinders..... single stage
Valves..... manually actuated
Pump..... engine driven
System pressure..... 1,200 psi (82.8 bars)
Strainer, on suction line..... 80 mesh
Hydraulic tank..... breather cap with dipstick
Auxiliary pump..... manually operated

Vehicle (standard)

Ford F-350 chassis, dual rear wheels, 11,000 lbs. (4,990 kg) GVW, automatic transmission, and power steering.

Operator Panel

Indicators..... power, stabilizers down, stair lights
Switches..... power, stair lights, "A" frame and stair interlocks
Controls..... stabilizers, stair, "A" frame

Shipping Dimensions

Length..... 288 in. (732 cm)
Width..... 90.7 in. (230 cm)
Height..... 145 in. (368 cm)
Weight..... 11,000 lbs. (4,990 kg)

Optional Items

Two-tone paint
Diesel engine
Outside controls
Electric auxiliary pump
Rotating beacon
Hourmeter
Morse control
Governor
Back-up alarm
Heavy-duty bumper/grill guard
Undercoating
Rustproofing
Rubberized stair treads and platforms

Dealer/Distributor

NMC-WOLLARD

2021 Truax Blvd, Eau Claire, WI 54703
Phone: 800-656-6867
Phone: 715-835-3151
Fax: 715-835-6625
Email: bsteingart@nmc-wollard.com
Website: www.nmc-wollard.com

4/08

This Page Intentionally Left Blank

**Event No. 7028 – REFURBISHED SELF-PROPELLED AIRCRAFT
STAIR TRUCK
Bidder’s Checklist – Envelope Requirements**

This checklist shall be attached to the outside of the envelope of a bid. Failure to complete, sign, and attach this checklist may result in a bid being deemed nonresponsive. Nonresponsive bids will be returned to the vendor unopened.

Firm name: Houston International Aircraft Support, Inc.
 Contact person: Traci Sadler / Robert Wyson
 Address: P.O. Box 2079 New Waverly, TX 77358 / 6402 South Acres Houston, TX
 Phone number: 713-643-7181
 Email address: Traci@houstonaircraft.net TT048

Envelope must contain the following documents:

Initials	Document
<u>TS</u>	Bid Proposal Form, Including Acknowledgement of Any Addenda
<u>TS</u>	Exception Sheet
<u>TS</u>	Contractor Affidavit and Agreement (Employee Eligibility Verification)
<u>TS</u>	Affidavit Verifying Status for City of Savannah Benefit Application

By signing below, bidder is attesting that all items listed in the checklist above have been included in the envelope.

Signature: Traci Sadler Date: 5/15/19

EXCEPTION SHEET

Event #7028

If the commodity(ies) and/or services proposed in the response to this bid is in anyway different from that contained in this proposal or bid, the bidder is responsible to clearly identify by specification section number, all such differences in the space provided below. Otherwise, it will be assumed that bidder's offer is in total compliance with all aspects of the proposal or bid.

Below are the exceptions to the stated specifications:

Obuson International Aircraft Support, Inc. is offering this Aircraft Passenger Stair Truck mounted on a Ford F350/GMC 3500 or similar chassis. Gasoline or Diesel to be determined. HIAS will require a 5090 non-refundable deposit in the event we are awarded this bid. Upon completion and shipment to Savannah, GA. the remaining balance is due net (30) from the time the truck is received.

5/15/19
Date

Luci Sadler
Signature
Obuson Int'l Aircraft Support, Inc.
Company
Sales
Title

BID PROPOSAL FORM

(SUBMIT AS THE COVER SHEET)

City of Savannah Purchasing Department
Savannah Civic Center
301 W. Oglethorpe Ave, 2nd floor
Savannah, Georgia 31401
ATTN: Purchasing Director

EVENT NUMBER: 7028

Business Location: (Check One)

- Chatham County
- City of Savannah
- Other

ALL BIDDERS MUST BE REGISTERED VENDORS ON THE CITY'S WEBSITE TO BE AWARDED AN EVENT. PLEASE REGISTER AT WWW.SAVANNAHGA.GOV.

MANUALLY SUBMITTED BIDS MUST BE SUBMITTED ON THIS BID PROPOSAL FORM IN ORDER TO BE CONSIDERED.

Name of Bidder: Douston Int'l Aircraft Support Inc.
 Street Address: P.O. Box 2079 New Waverly, TX. 77358 / 6402 S. Acres
Douston TX. 77048
 City, State, Zip Code: _____
 Phone: 713-643-7181 Fax: n/A
 Email: Tracia@doustonaircraft.net

DO YOU HAVE A BUSINESS TAX CERTIFICATE ISSUED IN THE STATE OF GEORGIA? (CHECK ONE) YES: _____ NO:

FROM WHAT CITY/COUNTY Houston / Harris County
TAX CERTIFICATE #: _____ FED TAX ID #: 76-0467210

INDICATE LEGAL FORM OF OWNERSHIP OF BIDDER (STATISTICAL PURPOSES ONLY):
CHECK ONE: CORPORATION PARTNERSHIP
 INDIVIDUAL OTHER (SPECIFY: _____)

Do you plan to subcontract any portion of this project? Yes _____ No

If yes, please complete the attached schedule of DBE participation. Also complete the schedule if you will be using any DBE suppliers.

ADDENDA ACKNOWLEDGEMENT

My signature below confirms my receipt of all addenda issued for this proposal.

Traci Sadler
Signature

*This acknowledgement is separate from my signature on the fee proposal form. My signature on the fee proposal form will not be deemed as an acknowledgement of addenda.

THE UNDERSIGNED PROPOSES TO FURNISH THE FOLLOWING ITEMS IN STRICT CONFORMANCE TO THE BID SPECIFICATIONS AND BID INVITATION ISSUED BY THE CITY OF SAVANNAH FOR THIS BID. ANY EXCEPTIONS ARE CLEARLY MARKED IN THE ATTACHED COPY OF BID SPECIFICATIONS.

ITEM NO	DESCRIPTION	ESTIMATED QUANTITY	UNIT PRICE	TOTAL
1	Refurbished Self-Propelled Aircraft Stair Truck	1 Each	48,000.00	48,000.00

TOTAL BID \$ 48,000.00

PAYMENT TERMS: PLEASE CHECK ONE AND FILL IN BLANKS

(Minimum of 10 working days must be allowed for discount to be considered in bid award)

Less % Days Prompt Payment Discount (if offered) (N/A)

Net - 30 Days (no discount offered) - 0 -

TOTAL NET BID

\$ 48,000.00

TIME REQUIRED FOR DELIVERY AFTER RECEIPT OF ORDER: (90) DAYS

I certify this bid complies with the General and Specific Specifications and Conditions issued by the City except as clearly marked in the attached copy.

Traci Sadler
Please Print Name

Traci Sadler
Authorization Signature

5/15/19
Date

CONTRACTOR AFFIDAVIT AND AGREEMENT
Employment Eligibility Verification

By executing this affidavit, the undersigned contractor verifies its compliance with O.C.G.A. 13-10-91, stating affirmatively that the individual, firm, or corporation which is contracting with the City of Savannah has registered with and is participating in a federal work authorization program* [any of the electronic verification of work authorization programs operated by the United States Department of Homeland Security or any equivalent federal work authorization program operated by the United States Department of Homeland Security to verify information of newly hired employees, pursuant to the Immigration Reform and Control Act of 1986 (IRCA), P.L. 99-603], in accordance with the applicability provisions and deadlines established in O.C.G.A. 13-10-91.

The undersigned further agrees that, should it employ or contract with any subcontractor(s) in connection with the physical performance of services pursuant to this contract with the City of Savannah, contractor will secure from such subcontractor(s) similar verification of compliance with O.C.G.A. 13-10-91 on the Subcontractor Affidavit provided in Rule 300-10-01-.08 or a substantially similar form. Contractor further agrees to maintain records of such compliance and provide a copy of each such verification to the City of Savannah at the time the subcontractor(s) is retained to perform such service.

EEV / Basic Pilot Program* User Identification Number

BY:

Contractor Name

Date

Signature of Authorized Officer or Agent

Printed Name of Authorized Officer or Agent

Title of Authorized Officer or Agent of Contractor

*As of the effective date of O.C.G.A. 13-10-91, the applicable federal work authorization program is the "EEV / Basic Pilot Program" operated by the U. S. Citizenship and Immigration Services Bureau of the U.S. Department of Homeland Security, in conjunction with the Social Security Administration (SSA).

N/A

Instructions for Completing Contractor Affidavit and Agreement Form

As required under Senate Bill 529 – “Georgia Security and Immigration Compliance Act” of 2006, O.C.G.A. Section 2, Article 3 13-10-91, public employers, their contractors and subcontractors are required to verify the work eligibility of all newly hired employees through an electronic federal work authorization program. The Georgia Department of Labor has added a new Chapter 300-10-1, entitled “Public Employers, Their Contractors and Subcontractors Required to Verify New Employee Work Eligibility Through a Federal Work Authorization Program,” to the Rules and Regulations of the State of Georgia. (See website: http://www.dol.state.ga.us/pdf/rules/300_10_1.pdf.) The new rules designate the “Employment Eligibility Verification (EEV) Basic Pilot Program” operated by the U.S. Citizenship and Immigration Services Bureau of the U.S. Department of Homeland Security as the electronic federal work authorization program to be utilized for these purposes. The EEV/Basic Pilot Program can be accessed at: <https://verify.uscis.gov/enroll/StartPage.aspx?JS=YES>. Bidders shall comply with this new rule and submit with your bid the attached “Contractor Affidavit and Agreement.”

Affidavit Verifying Status for City of Savannah Benefit Application

By executing this affidavit under oath, as an applicant for a City of Savannah, Georgia Business License or Occupation Tax Certificate, Alcohol License, Taxi Permit, Contract or other public benefit as reference in O.C.G.A. Section 50-36-1, I am stating the following with respect to my bid for a City of Savannah contract for TRACI SADLER. [Name of natural person applying on behalf of individual, business, corporation, partnership, or other private entity]

1.) I am a citizen of the United States.

OR

2.) I am a legal permanent resident 18 years of age or older.

OR

3.) I am an otherwise qualified alien (8 § USC 1641) or nonimmigrant under the Federal Immigration and Nationality Act (8 USC 1101 *et seq.*) 18 years of age or older and lawfully present in the United States.*

In making the above representation under oath, I understand that any person who knowingly and willfully makes a false, fictitious, or fraudulent statement or representation in an affidavit shall be guilty of a violation of Code Section 16-10-20 of the Official Code of Georgia.

Signature of Applicant: Traci Sadler Date: 5/15/19

Printed Name: TRACI SADLER

SUBSCRIBED AND SWORN
BEFORE ME ON THIS THE
15 DAY OF May, 2019

* n/a
Alien Registration number for non-citizens.

Notary Public Jacob Bush
My Commission Expires: May 31, 2022

***Instruction for Completing Systematic Alien Verification
for Entitlement (SAVE) Form***

O.C.G.A. § 50-36-1, requires Georgia's cities to comply with the federal **Systematic Alien Verification for Entitlements (SAVE) Program**. SAVE is a federal program used to verify that applicants for certain "public benefits" are legally present in the United States. Contracts with the City are considered "public benefits." Therefore, the successful bidder will be required to provide the Affidavit Verifying Status for City of Savannah Benefit Application prior to receiving any City contract. The affidavit is included as part of this bid package but is only required of the successful bidder.

Duplicate Copy

Event Number 7028 (7150)- Refurbished Self-Propelled Aircraft
Stair Truck

This Page Intentionally Left Blank

Event No. ⁵⁰7028 – REFURBISHED SELF-PROPELLED AIRCRAFT
STAIR TRUCK
Bidder’s Checklist – Envelope Requirements

This checklist shall be attached to the outside of the envelope of a bid. Failure to complete, sign, and attach this checklist may result in a bid being deemed nonresponsive. Nonresponsive bids will be returned to the vendor unopened.

Firm name: ADVANCE GSE CORP.
 Contact person: GEORGE BACHTIS.
 Address: 1060 BONHILL RD. MISSISSAUGA, ON L5T-1C4.
 Phone number: 905-564-5473
 Email address: SALES@ADVANCEGSE.COM.

Envelope must contain the following documents:

Initials	Document
<u>GB</u>	Bid Proposal Form, Including Acknowledgement of Any Addenda
<u>n/a</u>	Exception Sheet
<u>n/a</u>	Contractor Affidavit and Agreement (Employee Eligibility Verification)
<u>n/a</u>	Affidavit Verifying Status for City of Savannah Benefit Application

By signing below, bidder is attesting that all items listed in the checklist above have been included in the envelope.

Signature:  Date: May 14, 2019.

BID PROPOSAL FORM

(SUBMIT AS THE COVER SHEET)

City of Savannah Purchasing Department
Savannah Civic Center
301 W. Oglethorpe Ave, 2nd floor
Savannah, Georgia 31401
ATTN: Purchasing Director

EVENT NUMBER: 7028⁵⁰

Business Location: (Check One)
 Chatham County
 City of Savannah
 Other

ALL BIDDERS MUST BE REGISTERED VENDORS ON THE CITY'S WEBSITE TO BE AWARDED AN EVENT. PLEASE REGISTER AT WWW.SAVANNAHGA.GOV.

MANUALLY SUBMITTED BIDS MUST BE SUBMITTED ON THIS BID PROPOSAL FORM IN ORDER TO BE CONSIDERED.

Name of Bidder: ADVANCE GSE CORP.

Street Address: 1860 BONHILL RD.

City, State, Zip Code: MISSISSAUGA, ON. L5T-1C4.

Phone: 905-564-5473. Fax: 1-800-586-8171.

Email: SALES@ADVANCEGSE.COM

DO YOU HAVE A BUSINESS TAX CERTIFICATE ISSUED IN THE STATE OF GEORGIA? (CHECK ONE) YES: NO:

FROM WHAT CITY/COUNTY _____
TAX CERTIFICATE #: _____ FED TAX ID #: _____

INDICATE LEGAL FORM OF OWNERSHIP OF BIDDER (STATISTICAL PURPOSES ONLY):
CHECK ONE: CORPORATION PARTNERSHIP
 INDIVIDUAL OTHER (SPECIFY: _____)

Do you plan to subcontract any portion of this project? Yes No

If yes, please complete the attached schedule of DBE participation. Also complete the schedule if you will be using any DBE suppliers.

ADDENDA ACKNOWLEDGEMENT

My signature below confirms my receipt of all addenda issued for this proposal.

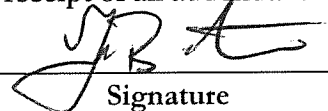

 Signature

*This acknowledgement is separate from my signature on the fee proposal form. My signature on the fee proposal form will not be deemed as an acknowledgement of addenda.

THE UNDERSIGNED PROPOSES TO FURNISH THE FOLLOWING ITEMS IN STRICT CONFORMANCE TO THE BID SPECIFICATIONS AND BID INVITATION ISSUED BY THE CITY OF SAVANNAH FOR THIS BID. ANY EXCEPTIONS ARE CLEARLY MARKED IN THE ATTACHED COPY OF BID SPECIFICATIONS.

ITEM NO	DESCRIPTION	ESTIMATED QUANTITY	UNIT PRICE	TOTAL
1	Refurbished Self-Propelled Aircraft Stair Truck	1 Each	39900	39900.

+ \$ 5000 Shipping TOTAL BID \$ 45500.00

PAYMENT TERMS: PLEASE CHECK ONE AND FILL IN BLANKS
 (Minimum of 10 working days must be allowed for discount to be considered in bid award)

___ Less ___ % ___ Days Prompt Payment Discount (if offered) (_____)
 Net - 30 Days (no discount offered) - 0 -
 TOTAL NET BID \$

=====

TIME REQUIRED FOR DELIVERY AFTER RECEIPT OF ORDER: 45 DAYS

I certify this bid complies with the General and Specific Specifications and Conditions issued by the City except as clearly marked in the attached copy.

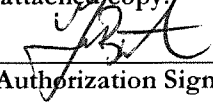
GEORGE BACHTIS  May 14 2019
 Please Print Name Authorization Signature Date



ADVANCE GSE CORP

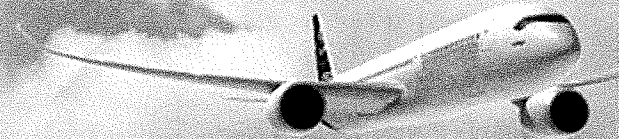

Advance GSE 200" Stair Truck



Shown with 2005 Ford chassis and used Wollard stair module



Event No. 7150
 "REFURBISHED SELF-PROPELLED AIRCRAFT STAIR TRUCK"
 Prepared for:

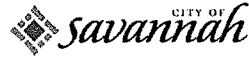

City of Savannah Purchasing Department
 Savannah Civic Center
 301 W. Oglethorpe Ave, 2nd floor
 Savannah, GA
 31401
 Attn: Purchasing Director
 Ship to:
 Purchasing Department
 640 Gulfstream Rd
 Savannah, GA
 31408
 Invoice to:
 City of Savannah
 Accounts Payable
 P.O. Box 1027
 Savannah, GA
 31402

Quote Date	Quote #	Quote Validity	Completed By:	FOB	Lead Time (approx)	HST # (Canada Only)
May14 , 2019	CITYOFSAV-STAIRS200-190514	30 days	George Bachtis	SAV	6 weeks	828592105RT0001

Quantity	Item	Year	Description	Unit Price	Total (USD)
1	STAIRS200	2005	Motorized Stairs - Ford F350 gasoline chassis (Refurbished)	\$39,900.00	\$39,900.00
	Inv# AD-1261		For servicing all aircraft with door sill height: 100" - 200"		
			Platform Capacity: 800 lbs		
			GVW = 10,000 lbs approx		
			Painted Fleet White, new lighting system, F & R stabilizers	Included	
			All systems refurbished and/or serviced including:		
			Engine, Transmission, Hydraulics & Electrical (Serviced)		
1	AMBCN		Amber Beacon (cab mounted)		Included
4	KEYS		Key sets		Included

Notes: Warranty: 90 days - parts.

Terms:

- 50% Down Payment at time of order
- Remainder due prior to shipping (Not negotiable)
- **Canada & US military (government) payment terms accepted**
- Product(s) remain property of ADVANCE GSE CORP until paid in full. Conditions of sale are published on our website.
- Deposits and payments can be made via International Wire Transfer and can be made payable to Advance GSE CORP in USD.
- Please allow up to 14 days for checks to clear from within Canada, 21 days from the United States.
- No checks accepted from outside North America. Wire transfer only
- Applicable Canadian taxes will be applied

Subtotal	\$39,900.00
Shipping	\$5,600.00
Total (USD)	\$45,500.00



1860 Bonhill Rd, Mississauga, ONTARIO - CANADA - L5T-1C4
 1 (905) 564- 5473 (5GSE) Fax: 1(800) 586-8171
 Email: sales@advancegse.com URL: www.advancegse.com

REFURBISHED SELF-PROPELLED AIRCRAFT STAIR TRUCK

EVENT NO. ~~7028~~⁵⁰

SPECIFICATIONS AND SPECIAL CONDITIONS

4.0 The purpose of these specifications is to describe requirements for one (1) refurbished self-propelled aircraft stair truck for use by the Savannah Airport Commission in its daily operations.

To submit pricing electronically for this event, enter pricing for each line item shown under the lines tab on the event summary. To enter pricing manually, complete the attached bid proposal form. Manually submitted bids must be submitted on the bid proposal forms contained in these specifications in order to be considered.

4.1 Detailed Specifications:

4.1.1 Refurbished only. ✓

4.1.2 Truck mounted or Tug mounted. ✓

4.1.3 Self-Mobile. ✓

4.1.4 Engine: Gasoline powered. Diesel acceptable. ✓

4.1.5 Transmission: Automatic. ✓

4.1.6 Capability to service 737-700 up to and including 777-300.

4.1.7 Two each stabilizers ✓

4.1.8 Amber beacon ✓

4.1.9 Functioning headlights, taillights, and horn ✓

4.1.10 If key operated, unit shall include a minimum of four key sets. ✓

4.2 Delivery

4.2.1 Please include estimated delivery time. ✓

4.2.2 The successful bidder will be responsible for delivering the aircraft stair truck to the Purchasing Department, 640 Gulfstream Road, Savannah, Georgia 31408. ✓

5.0 General Conditions

5.1 The bid response shall include all documents required in the bidder's checklist.

All referenced documents must be completed and returned in their entirety to constitute a complete bid.



5.2 Original invoices should be sent to:

City of Savannah
Accounts Payable
P.O. Box 1027
Savannah, Georgia 31402

5.3 The vendor is responsible for determining and acknowledging any addenda issued in connection with this bid solicitation. All addenda issued for this event must be acknowledged in order for a bid to be considered.

5.4 To be awarded bids, vendors must be registered as suppliers on the City of Savannah's website at www.savannahga.gov.

5.5 This contract will be awarded to the vendor offering the lowest net price to the Commission, and meeting or exceeding all specifications herein.

5.6 All bids must be submitted in **DUPLICATE**.

EXCEPTION SHEET

Event #7028

If the commodity(ies) and/or services proposed in the response to this bid is in anyway different from that contained in this proposal or bid, the bidder is responsible to clearly identify by specification section number, all such differences in the space provided below. Otherwise, it will be assumed that bidder's offer is in total compliance with all aspects of the proposal or bid.

Below are the exceptions to the stated specifications:

n/a .

Date

Signature

Company

Title

J.

CONTRACTOR AFFIDAVIT AND AGREEMENT
Employment Eligibility Verification

By executing this affidavit, the undersigned contractor verifies its compliance with O.C.G.A. 13-10-91, stating affirmatively that the individual, firm, or corporation which is contracting with the City of Savannah has registered with and is participating in a federal work authorization program* [any of the electronic verification of work authorization programs operated by the United States Department of Homeland Security or any equivalent federal work authorization program operated by the United States Department of Homeland Security to verify information of newly hired employees, pursuant to the Immigration Reform and Control Act of 1986 (IRCA), P.L. 99-603], in accordance with the applicability provisions and deadlines established in O.C.G.A. 13-10-91.

The undersigned further agrees that, should it employ or contract with any subcontractor(s) in connection with the physical performance of services pursuant to this contract with the City of Savannah, contractor will secure from such subcontractor(s) similar verification of compliance with O.C.G.A. 13-10-91 on the Subcontractor Affidavit provided in Rule 300-10-01-.08 or a substantially similar form. Contractor further agrees to maintain records of such compliance and provide a copy of each such verification to the City of Savannah at the time the subcontractor(s) is retained to perform such service.

EEV / Basic Pilot Program* User Identification Number

BY:

Contractor Name

Date

Signature of Authorized Officer or Agent

Printed Name of Authorized Officer or Agent

Title of Authorized Officer or Agent of Contractor

*As of the effective date of O.C.G.A. 13-10-91, the applicable federal work authorization program is the "EEV / Basic Pilot Program" operated by the U. S. Citizenship and Immigration Services Bureau of the U. S. Department of Homeland Security, in conjunction with the Social Security Administration (SSA).

* * * * *

n/a .
J .

Instructions for Completing Contractor Affidavit and Agreement Form

As required under Senate Bill 529 – "Georgia Security and Immigration Compliance Act" of 2006, O.C.G.A. Section 2, Article 3 13-10-91, public employers, their contractors and subcontractors are required to verify the work eligibility of all newly hired employees through an electronic federal work authorization program. The Georgia Department of Labor has added a new Chapter 300-10-1, entitled "Public Employers, Their Contractors and Subcontractors Required to Verify New Employee Work Eligibility Through a Federal Work Authorization Program," to the Rules and Regulations of the State of Georgia. (See website: http://www.dol.state.ga.us/pdf/rules/300_10_1.pdf.) The new rules designate the "Employment Eligibility Verification (EEV) Basic Pilot Program" operated by the U.S. Citizenship and Immigration Services Bureau of the U.S. Department of Homeland Security as the electronic federal work authorization program to be utilized for these purposes. The EEV/Basic Pilot Program can be accessed at: <https://verify.uscis.gov/enroll/StartPage.aspx?JS=YES>. Bidders shall comply with this new rule and submit with your bid the attached "Contractor Affidavit and Agreement."

n/a.

y.

Affidavit Verifying Status for City of Savannah Benefit Application

By executing this affidavit under oath, as an applicant for a City of Savannah, Georgia Business License or Occupation Tax Certificate, Alcohol License, Taxi Permit, Contract or other public benefit as reference in O.C.G.A. Section 50-36-1, I am stating the following with respect to my bid for a City of Savannah contract for _____. [Name of natural person applying on behalf of individual, business, corporation, partnership, or other private entity]

1.) _____ I am a citizen of the United States.

OR

2.) _____ I am a legal permanent resident 18 years of age or older.

OR

3.) _____ I am an otherwise qualified alien (8 § USC 1641) or nonimmigrant under the Federal Immigration and Nationality Act (8 USC 1101 *et seq.*) 18 years of age or older and lawfully present in the United States.*

In making the above representation under oath, I understand that any person who knowingly and willfully makes a false, fictitious, or fraudulent statement or representation in an affidavit shall be guilty of a violation of Code Section 16-10-20 of the Official Code of Georgia.

Signature of Applicant: _____ Date _____

Printed Name: _____

SUBSCRIBED AND SWORN
BEFORE ME ON THIS THE
____ DAY OF _____, 20____

* _____
Alien Registration number for non-citizens.

Notary Public
My Commission Expires:

n/c
y.

***Instruction for Completing Systematic Alien Verification
for Entitlement (SAVE) Form***

O.C.G.A. § 50-36-1, requires Georgia's cities to comply with the federal **Systematic Alien Verification for Entitlements (SAVE) Program**. SAVE is a federal program used to verify that applicants for certain "public benefits" are legally present in the United States. Contracts with the City are considered "public benefits." Therefore, the successful bidder will be required to provide the Affidavit Verifying Status for City of Savannah Benefit Application prior to receiving any City contract. The affidavit is included as part of this bid package but is only required of the successful bidder.